

E

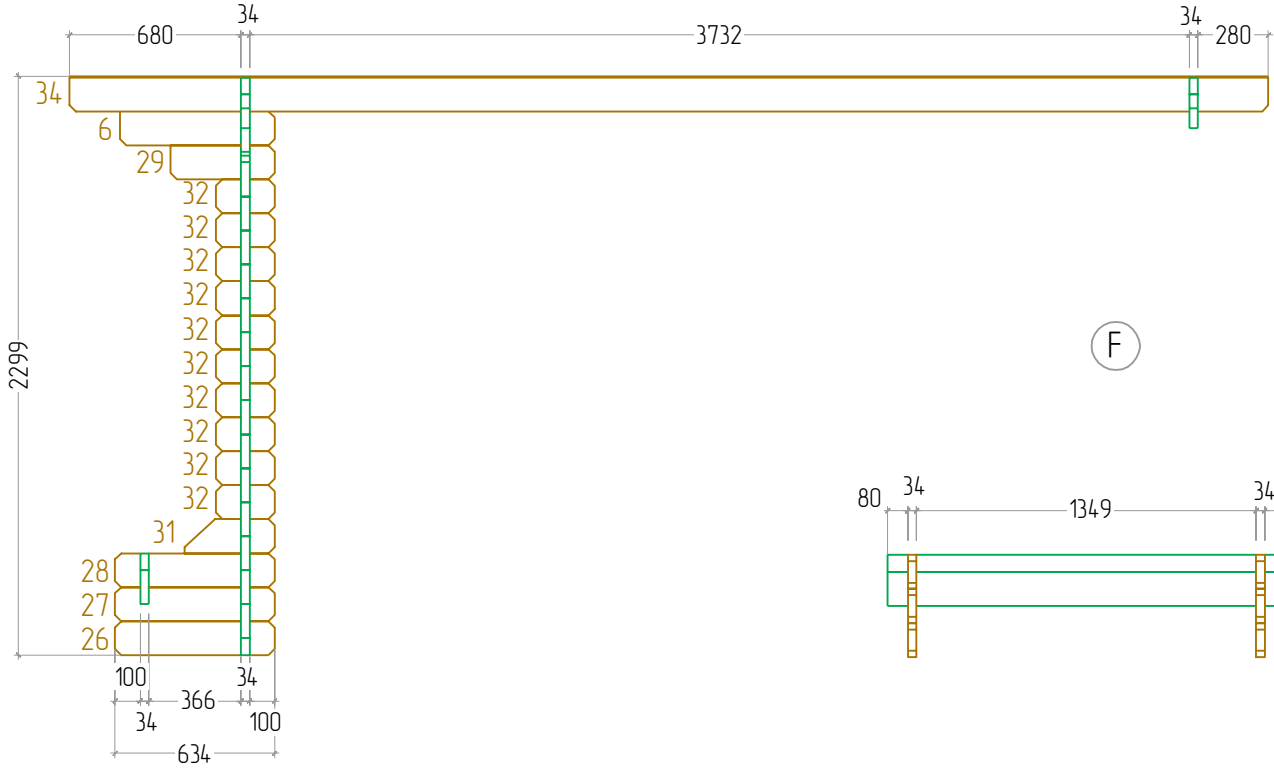

F

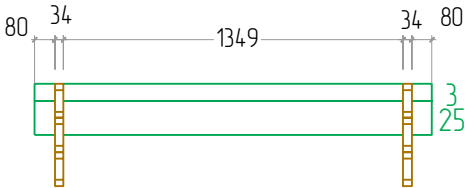

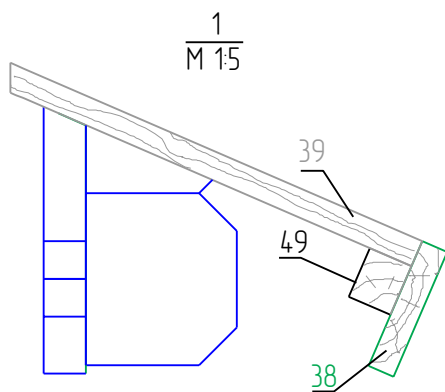
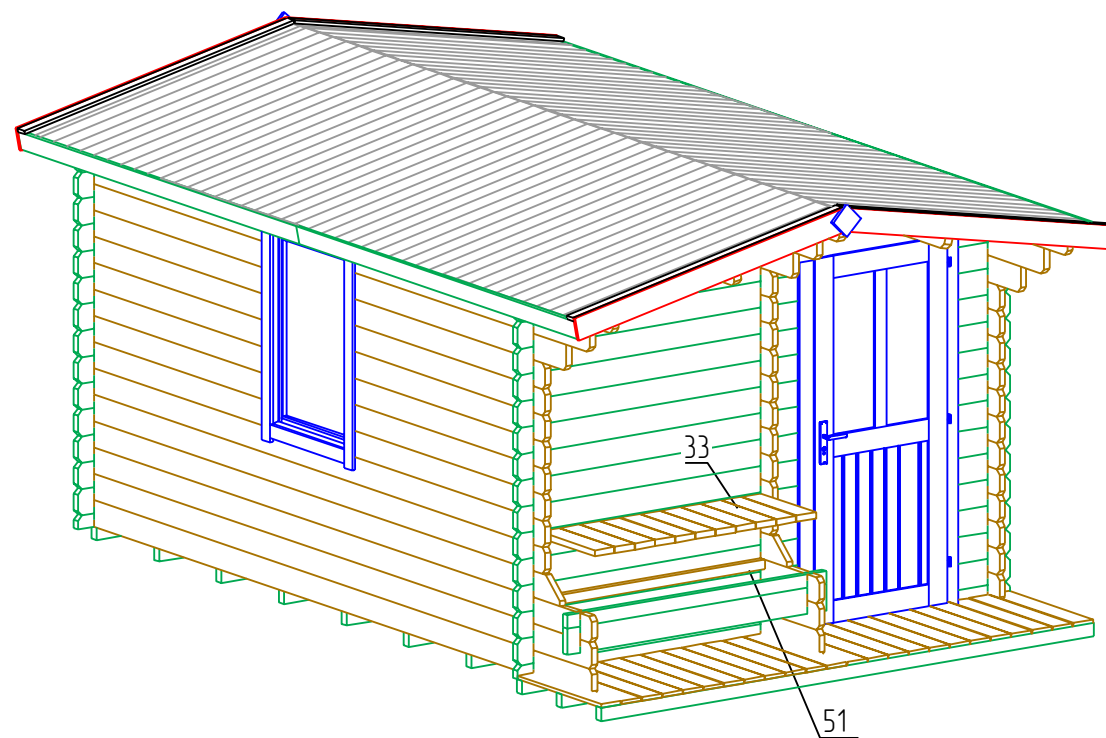
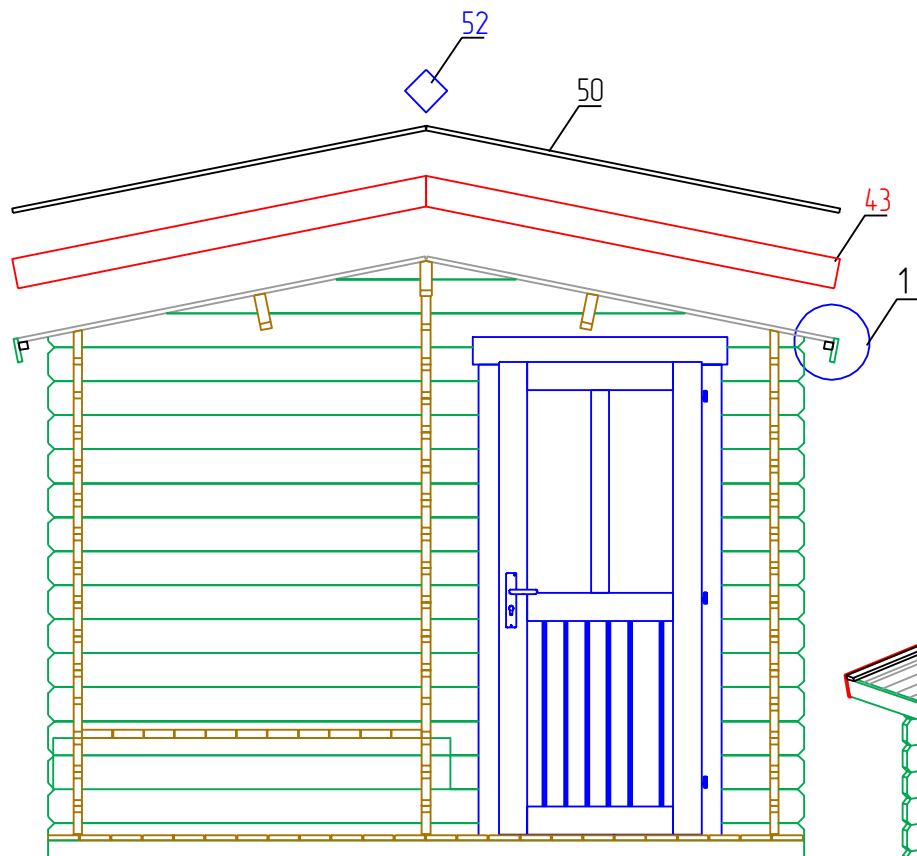

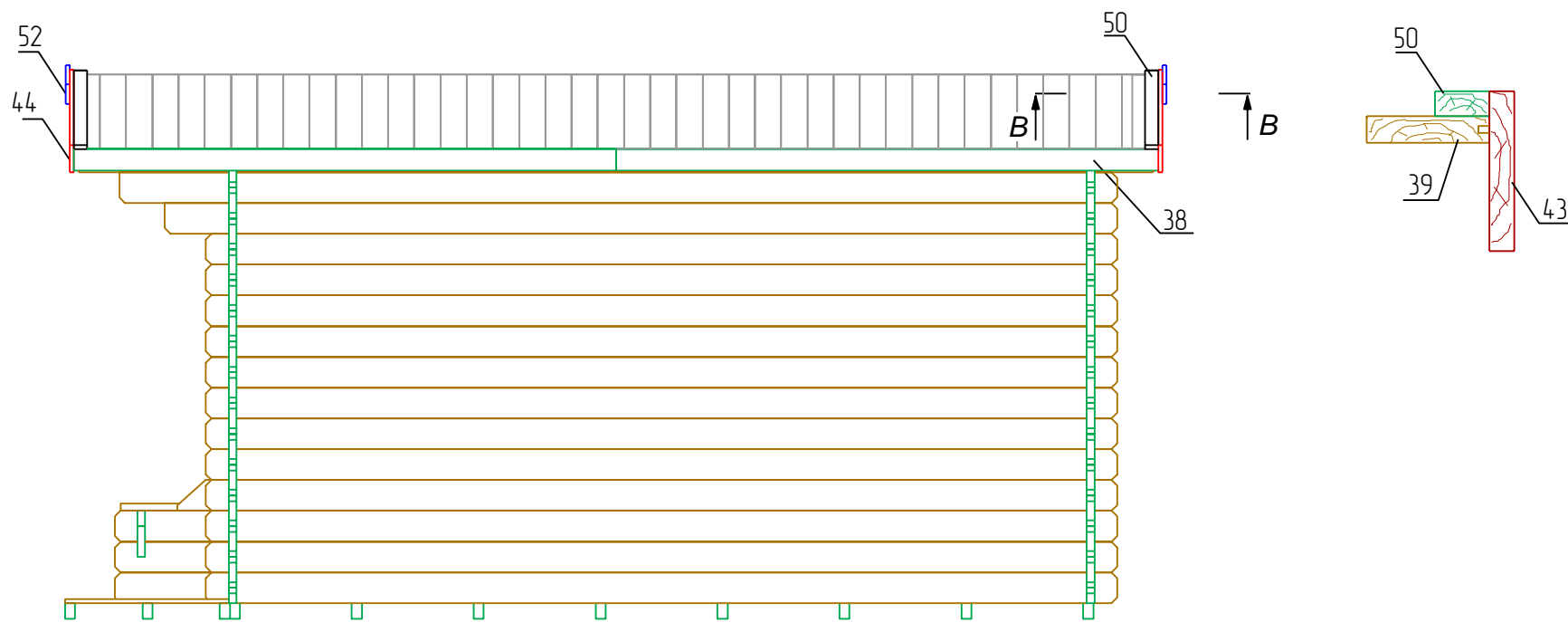

Tom 34 3x4



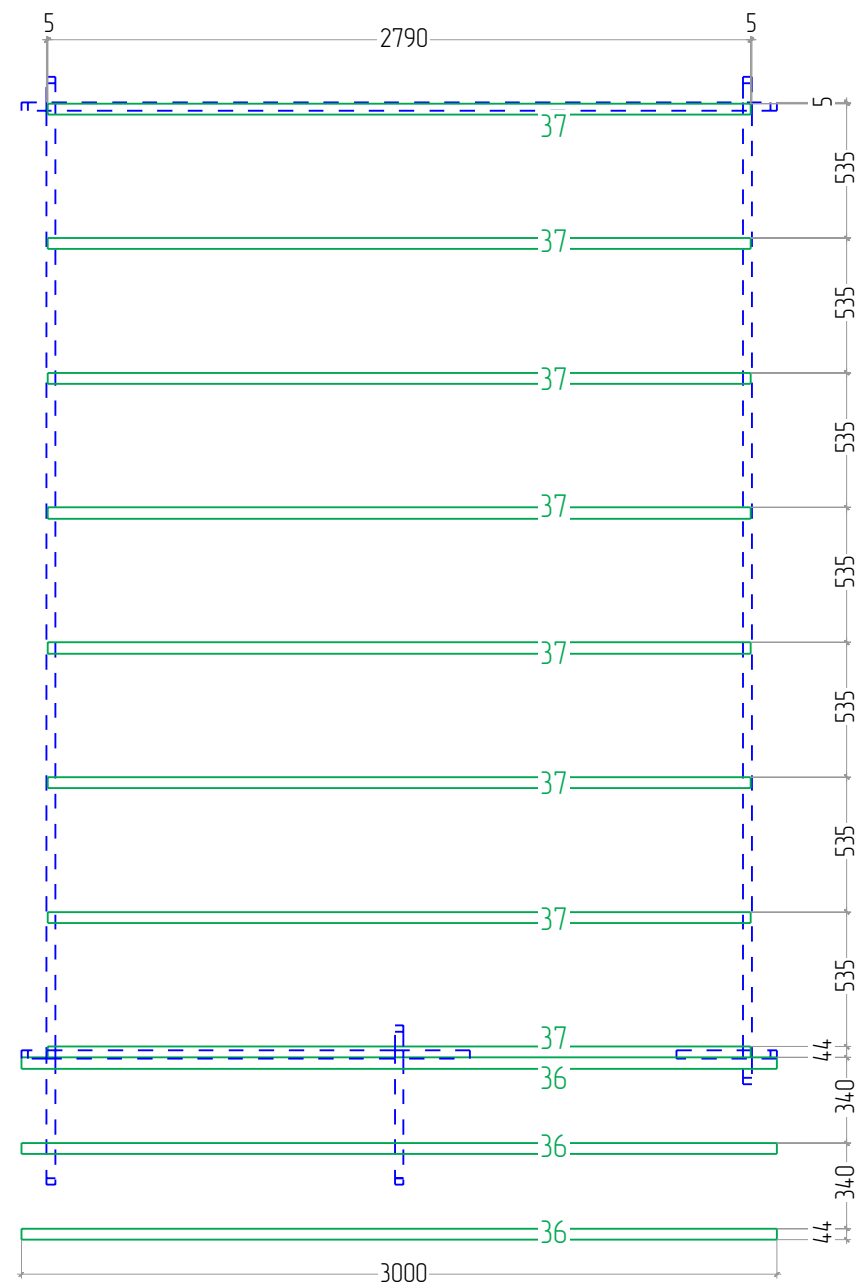



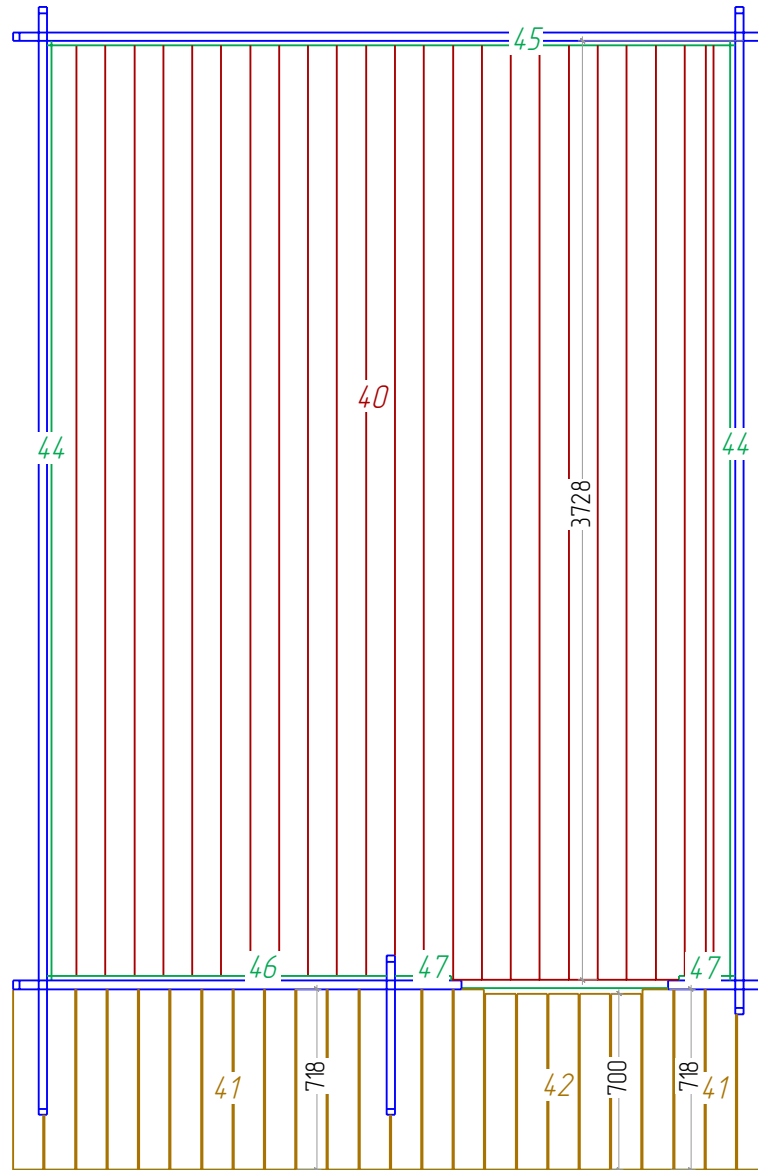

Boarding joist plan
Trummplan
Lambourde plan

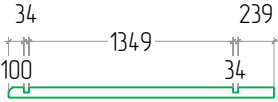

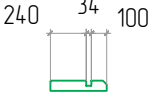
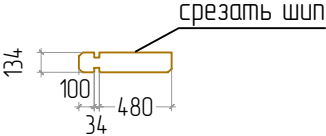

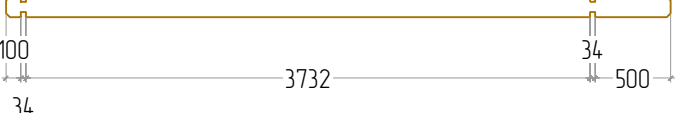



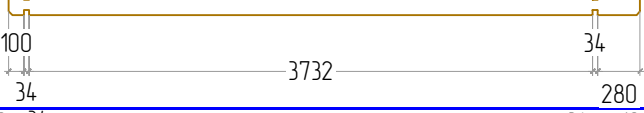
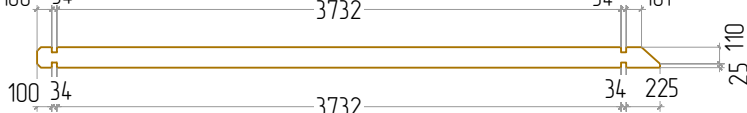





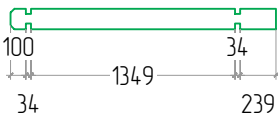

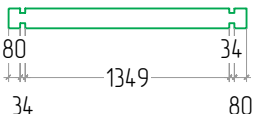
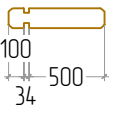
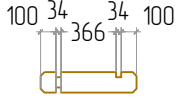
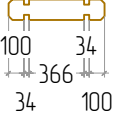
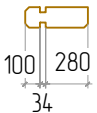
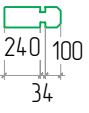
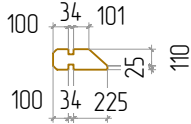

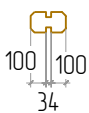

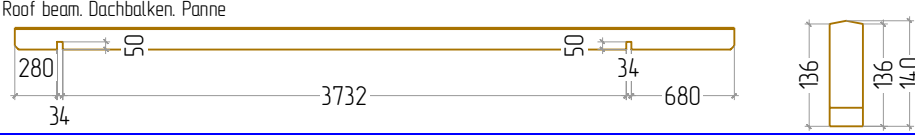
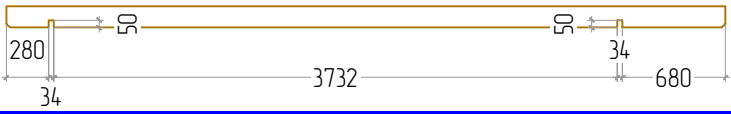
Tom 34 3x4







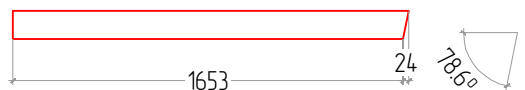

Plan of the floor board
Plan der furbodenbretter
Le plan des plaches du plancher



| № | Том 34 3x4 | St. | Schnitt | Lange |
|----|--|-----|----------|--------|
| 1 |  | 1 | 34x67.5 | 3000mm |
| 2 |  | 1 | 34x67.5 | 1756mm |
| 3 |  | 1 | 34x67.5 | 1577mm |
| 4 |  | 1 | 34x67.5 | 374mm |
| 6 |  | 1 | 34x134.4 | 614mm |
| 7 |  | 1 | 34x135 | 4760mm |
| 8 |  | 1 | 34x135 | 4760mm |
| 9 |  | 1 | 34x135 | 4400mm |
| 10 |  | 1 | 34x135 | 4400mm |
| 11 |  | 1 | 34x135 | 4400mm |
| 12 |  | 1 | 34x135 | 4380mm |
| 13 |  | 1 | 34x135 | 4180mm |
| 14 |  | 1 | 34x135 | 4125mm |

| Nº | Tom 34 3x4 | St. | Schnitt | Länge |
|----|---|------|---------|--------|
| 15 |  | 14+1 | 34x135 | 4000mm |
| 16 |  | 14 | 34x135 | 3000mm |
| 21 |  | 1 | 34x135 | 2020mm |
| 22 |  | 1 | 34x135 | 1820mm |
| 23 |  | 14 | 34x135 | 1756mm |
| 24 |  | 14 | 34x135 | 1640mm |
| 25 |  | 1 | 34x135 | 1577mm |
| 26 |  | 1 | 34x135 | 634mm |
| 27 |  | 1 | 34x135 | 634mm |
| 28 |  | 1 | 34x135 | 634mm |
| 29 |  | 1 | 34x135 | 414mm |
| 30 |  | 14 | 34x135 | 374mm |
| 31 |  | 1 | 34x135 | 359mm |

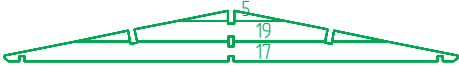
| Nº | Tom 34 3x4 | St. | Schnitt | Longe |
|----|---|------|---------|--------|
| 32 |  | 10 | 34x135 | 234mm |
| 33 |  | 11 | 32x120 | 475mm |
| 34 | Roof beam. Dachbalken. Panne  | 1 | 44x140 | 4760mm |
| 35 | Roof beam. Dachbalken. Panne  | 2 | 44x140 | 4760mm |
| 36 | Foundation Fundament Solve  | 3 | 44x68 | 3000mm |
| 37 | Foundation Fundament Solve  | 8 | 44x68 | 2790mm |
| 38 | Roof side boards Traufenbrett Planche de rive  | 4 | 18x95 | 2380mm |
| 39 | Roof boards Dachbretter Volige  | 84+1 | 20x115 | 1650mm |
| 40 | Floor boards Fu ssboden Lame de plancher  | 24+1 | 20x115 | 3728mm |
| 41 |  | 20 | 18x120 | 718mm |
| 42 |  | 5 | 18x120 | 700mm |
| 43 | Fascia board Giebelblende Planch de rive facade  | 4 | 18x120 | 1677mm |
| 44 | Floor edge trim Fu bleisten Plinthe plancher  | 2 | 18x20 | 3732mm |

| Nº | Tom 34 3x4 | St. | Schnittl | Lange |
|-----|---|-----|----------|--------|
| 45 | Floor edge trim Fu bleisten Plinthe plancher  | 1 | 18x20 | 2732mm |
| 46 | Floor edge trim Fu bleisten Plinthe plancher  | 1 | 18x20 | 1349mm |
| 47 | Floor edge trim Fu bleisten Plinthe plancher  | 2 | 18x20 | 197mm |
| 49 | Roof edge reinforcement Traufleisten Tasseau  | 4 | 28x34 | 2380mm |
| 50 | Roofing felt fillet Giebelabschlussbrett Latte de finition couverture  | 4 | 18x58 | 1673mm |
| 51 |  | 1 | 50x34 | 1349mm |
| | Door Tur 1958mmx870mm La porte | 1 | | |
| | Window Fenetre 1080mmx720mm Fenster | 1 | | |
| 52 | Diamond Raute  Diamant | 2 | 18x120 | 120mm |
| W-1 |  | 1 | | |
| W-2 |  | 1 | | |

W-1

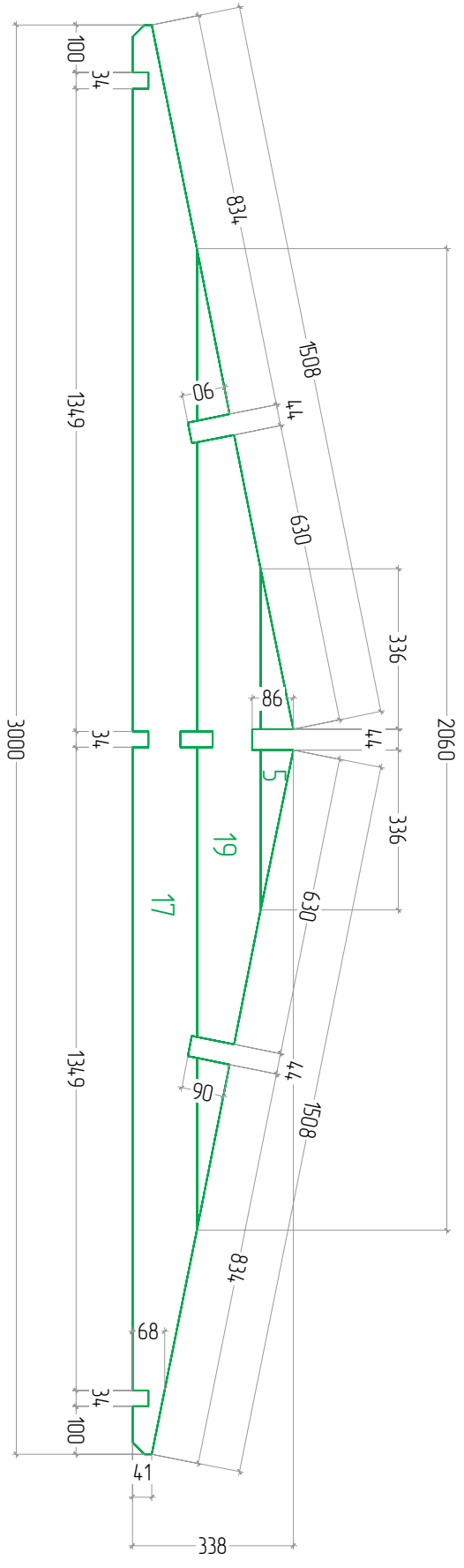

W-2

